

# DLH-1043

## 12V Low Voltage, Max. 50W MR-16

### 4" NON-IC Type Shallow Housing For New Construction

Catalog #		Type
Project		Date
Prepared by		

**HALOGEN**

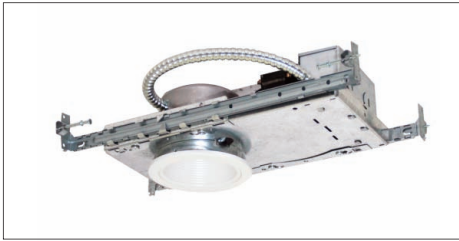

#### DESCRIPTION

The DLH-1043 is a 4" aperture low voltage housing for use in low ceiling spaces for accent and task lighting.

#### APPLICATION

The DLH-1043 is designed for use in both non-insulated and insulated ceilings. Insulation material must be kept a minimum of 3" from all sides of the housing.

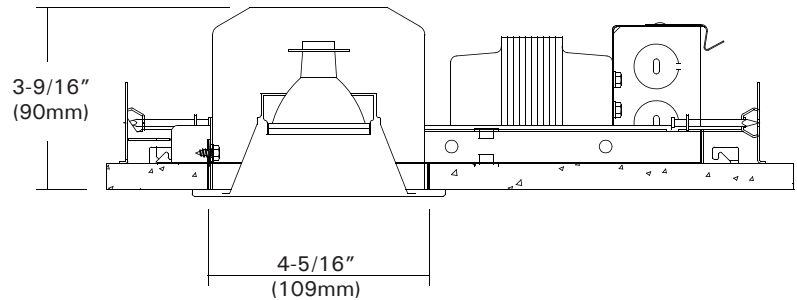

#### DESIGN FEATURES

**Ceiling Cut-out : 4-3/8"**  
**Lamp, Max, Watt. : 50W**

##### ◦ Housing

- Single wall aluminum housing.
- 3-1/2" height allows use in 2"X6" joist construction.
- Housing adjusts for ceilings up to 1-3/8" thick.

##### ◦ Junction Box

- Listed for through branch circuit wiring. (Max.8 No 12 AWG 90°C branch circuit conductors. (4 in, 4 out)
- (5)1/2" knockouts with true pry-out slots and (4) knockouts with Romex cable clamp.
- Ground wire provided on J-box.

##### ◦ Mounting Frame

- Galvanized steel construction.
- 8" L x 5-1/2" W

##### ◦ Bar Hangers

- Maximum extension of 24" allows for extra distance between joists.
- Housing can be positioned at any point within 24" joist span.
- Score lines allow "toolless" shortening for 12" joists. Bar hangers may be repositioned 90 degrees.
- Integral T-bar clips snaps onto T-bars and no additional clips are required.

##### ◦ Just-A-Nail

- Pre-installed nail bars with vertical slots are used to evenly align the bars horizontally after nailing halfway into wood joists.

##### ◦ Socket

- Ceramic socket with aluminum heat shield for Bi Pin MR16 lamps.

##### ◦ Lamp

- One 12V, 50W MR16 lamp. - See trim page for more details.

##### ◦ Transformer

- 120V magnetic transformer steps line voltage down to lamp operating voltage for lamps up to 50W.
- Available 277V-12V transformer.

##### ◦ Thermal Protector

- Self-resetting thermal detector deactivates fixture if overheating occurs due to improper lamping or insulation.

##### \* Listing

- UL, c-UL listed for damp location.
- UL, c-UL listed for feed through.

##### • Just-A-Nail

Adjustable nail hanger bar for easy alignment.

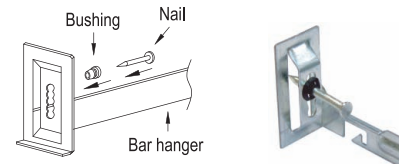

**JUST-A-NAIL**

##### • Optional "Quick Connect" Push-in wire connectors.

- Three "Quick Connectors"
- Pre-installed push-in wire connectors for fast and easy wiring.

# Trims

## 4" Halogen Trims For

DLH-304, DLH-304R, ICH-304AT, DLH-104, DLH-104R, ICH-104AT,  
DLH-1043, DLH-1043R, DLH-1047, DLH-1047R

Catalog #		Type
Project		Date
Prepared by		

### HALOGEN

**TMH-24B** Adjustable Baffle  
**NON-IC, IC : 50W MR16, 12V or 120V**  
**DLH-1047 : 75W MR16, 12V**  
 White Metal Trim Ring  
 O.D : 4-7/8"



TMH-24B-WH

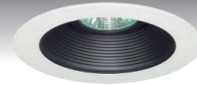

TMH-24B-BK



TMH-24B-CH

**TMH-24R** Adjustable Reflector  
**NON-IC, IC : 50W MR16, 12V or 120V**  
**DLH-1047 : 75W MR16, 12V**  
 White Metal Trim Ring  
 O.D : 4-7/8"



TMH-24R-CL



TMH-24R-GD

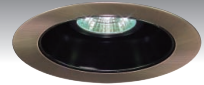

TMH-24R-BK-MO

**TMH-48E** Eyeball  
**NON-IC, IC : 50W MR16, 12V or 120V**  
**DLH-1047 : 75W MR16, 12V**  
 White Metal Trim Ring  
 O.D : 4-7/8"



TMH-48E-WH



TMH-48E-PB



TMH-48E-MO

**TMH-43** Retractable Wall Wash  
**NON-IC, IC : 50W MR16, 12V**  
**DLH-1047 : 75W MR16, 12V**  
 White Metal Trim Ring  
 O.D : 4-7/8"



TMH-43-WH



TMH-43-CH



TMH-43-MO

**TMH-47** Adjustable Wall Wash  
**NON-IC, IC : 50W MR16, 12V or 120V**  
**DLH-1047 : 75W MR16, 12V**  
 White Metal Trim Ring  
 O.D : 4-7/8"



TMH-47-WH



TMH-47-SN



TMH-47-AN

**TMH-34P** Pin Hole w/ Baffle  
**NON-IC : 50W MR16, 12V or 120V**  
**IC : 35W MR16, 12V or 120V**  
**DLH-1047 : 75W MR16, 12V**  
 White Metal Trim Ring  
 O.D : 4-7/8"



TMH-34P-WH

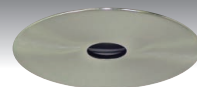

TMH-34P-SN

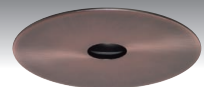

TMH-34P-MO

**TMH-29** Slotted Wall Wash w/ Baffle  
**NON-IC : 50W MR16, 12V or 120V**  
**IC : 35W MR16, 12V or 120V**  
**DLH-1047 : 75W MR16, 12V**  
 White Metal Trim Ring  
 O.D : 4-7/8"



TMH-29-WH



TMH-29-BK



TMH-29-BK-MO

**TMH-28** Gimbal  
**NON-IC, IC : 50W MR16, 12V or 120V**  
**DLH-1047 : 75W MR16, 12V**  
 White Metal Trim Ring  
 O.D : 4-7/8"

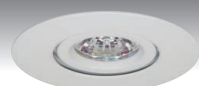

TMH-28-WH

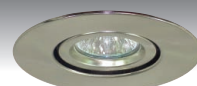

TMH-28-SN

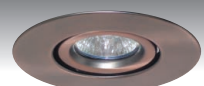

TMH-28-MO

# Trims

## 4" Halogen Trims For

DLH-304, DLH-304R, ICH-304AT, DLH-104, DLH-104R, ICH-104AT,  
DLH-1043, DLH-1043R, DLH-1047, DLH-1047R

Catalog #		Type
Project		Date
Prepared by		

### HALOGEN

**TMH-84E** Eyeball w/ Baffle  
**NON-IC : 50W MR16, 12V or 120V**  
**DLH-1047 : 75W MR16, 12V**  
 White Metal Trim Ring  
 O.D : 4-7/8"



TMH-84E-WH



TMH-84E-BK



TMH-84E-BK-PB

**TMH-35B** Pin Spot  
**NON-IC : 50W MR16, 12V or 120V**  
**IC : 35W MR16, 12V or 120V**  
**DLH-1047 : 75W MR16, 12V**  
 White Metal Trim Ring  
 O.D : 4-7/8"



TMH-35B-WH



TMH-35B-BK



TMH-35B-BK-SN

**TMH-215** Shower Fresnel Lens  
**NON-IC : 50W MR16, 12V or 120V**  
**IC : 35W MR16, 12V or 120V**  
**DLH-1047 : 75W MR16, 12V**  
 White Metal Trim Ring  
 O.D : 4-7/8"



TMH-215-WH



TMH-215-SN



TMH-215-MO

**TMH-216** Shower Drop Opal Lens  
**NON-IC : 50W MR16, 12V or 120V**  
**IC : 35W MR16, 12V or 120V**  
**DLH-1047 : 75W MR16, 12V**  
 White Metal Trim Ring  
 O.D : 4-7/8"



TMH-216-WH



TMH-216-SN



TMH-216-CH

**TMH-217** Shower Albalite Lens  
**NON-IC : 50W MR16, 12V or 120V**  
**IC : 35W MR16, 12V or 120V**  
**DLH-1047 : 75W MR16, 12V**  
 White Metal Trim Ring  
 O.D : 4-7/8"



TMH-217-WH

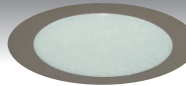

TMH-217-CH

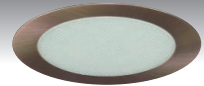

TMH-217-MO

**TMH-25**  
 Wall Wash  
**NON-IC : 50W MR16, 12V or 120V**  
**IC : 35W MR16, 12V or 120V**  
**DLH-1047 : 75W MR16, 12V**  
 White Metal Trim Ring  
 O.D : 4-7/8"



TMH-25-WH

**TMH-25B**  
 Wall Wash w/ Baffle  
**NON-IC : 50W MR16, 12V or 120V**  
**IC : 35W MR16, 12V or 120V**  
**LH-4107 : 75W MR16, 12V**  
 White Metal Trim Ring  
 O.D : 4-7/8"



TMH-25B-WH



TMH-25B-BK

### ORDERING INFORMATION

Choose the catalog / finish codes that best suit your needs and enter it on the appropriate line.

TRIM MODEL	REFLECTOR	BAFFLE	METAL RING
CL	:Clear	WH	:White
WH	:White	BK	:Black
GD	:Gold	SN	:Satin Nickel
MA	:Matte Platinum	AN	:Antique Nickel
CP	:Champagne	AC	:Antique Copper
PR	:Pewter	MO	:Mocha
HC	:Haze Clear	CA	:Cappuccino
		CH	:Chrome
		UN	:Natural Steel
		PB	:Polished Brass

Examples:

TMH-43-WH = Retractable White Wall Wash  
 TMH-24B-BK-WH = White Metal Trim Ring w/ Black Baffle  
 TMH-35B-BK-WH = White Trim Ring w/ Black Baffle